

# Kliegl 500 Watt 4 1/2" Fresnel



## SPECIFICATIONS

Fresnel lens spotlight consisting of a cast aluminum housing reinforced for highest unit strength and masked with efficient light baffles; supported by a steel yoke mounted on cast aluminum support buses; a black heat resistant tilt adjustment knob; a lockable carriage slide focusing control knob which moves from full SPOT to full FLOOD position; an Alzak® aluminum spherical reflector on a movable carriage; integral color frame grooves; a TP-22 medium 2 pin socket for a tungsten-halogen 500-750 watt lamp; a 4 1/2" heat resisting Fresnel lens with optically fluted back in a side hinged door, with spring loaded pin type latch for easy relamping; and 36" leads properly stripped and tinned with a 20 ampere 2 pole 3 wire male connector. Each unit shall be equipped with a "C" pipe clamp, and a safety cable.

Using a 500W lamp, this unit shall produce a field angle of 18 degrees in SPOT position and 54 degrees in FLOOD position and which equals or exceed 21,000 candle power in the SPOT position and 5,000 candle power in the FLOOD position. Units shall be Kliegl #3604 Fresnel spotlights.

Provide \_\_\_\_\_ KLIEGL #3604 fixture(s) with \_\_\_\_\_ color frame and \_\_\_\_\_ lamp(s) with ANSI Code # \_\_\_\_\_.

Fill in Project Information Here

## Kliegl Model

### QUICK SELECTOR

#### SPOT

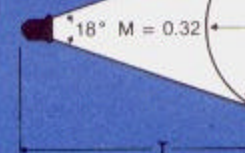

TYPICAL THROW DISTANCE  
3-8 meters; 10-25 feet  
Field Dia. (F) = Throw Dist

#### FLOOD

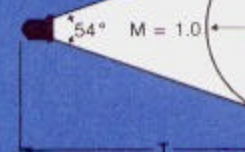

TYPICAL THROW DISTANCE  
2-6 meters; 6-20 feet  
Field Dia. (F) = Throw Dist

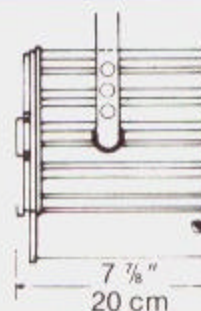

Weight: 9 Lbs.

### ACCESSORIES

13604	Color Frame
23604	8 way Barndoor
1850	"C" Clamp (furr standard equip)
1860C	18" "C" Clamp
1415	18" Spoke Base
1420	19" Roller Caster
53604	Top Hat
14360A	Portable Stand
1438	6" Table Base
1867	Scenery Clamp

### CONNECTORS

All configurations are U

955G	2 Pole 3 Wire 20 Connector (furr standard equip)
TLG	2 Pole 3 Wire 20

Kliegl Model 3604

500 Watt  
4 1/2" Fresnel

Independent Lab. Data

U.L. Listed and Labeled Union Made in the U.S.A.

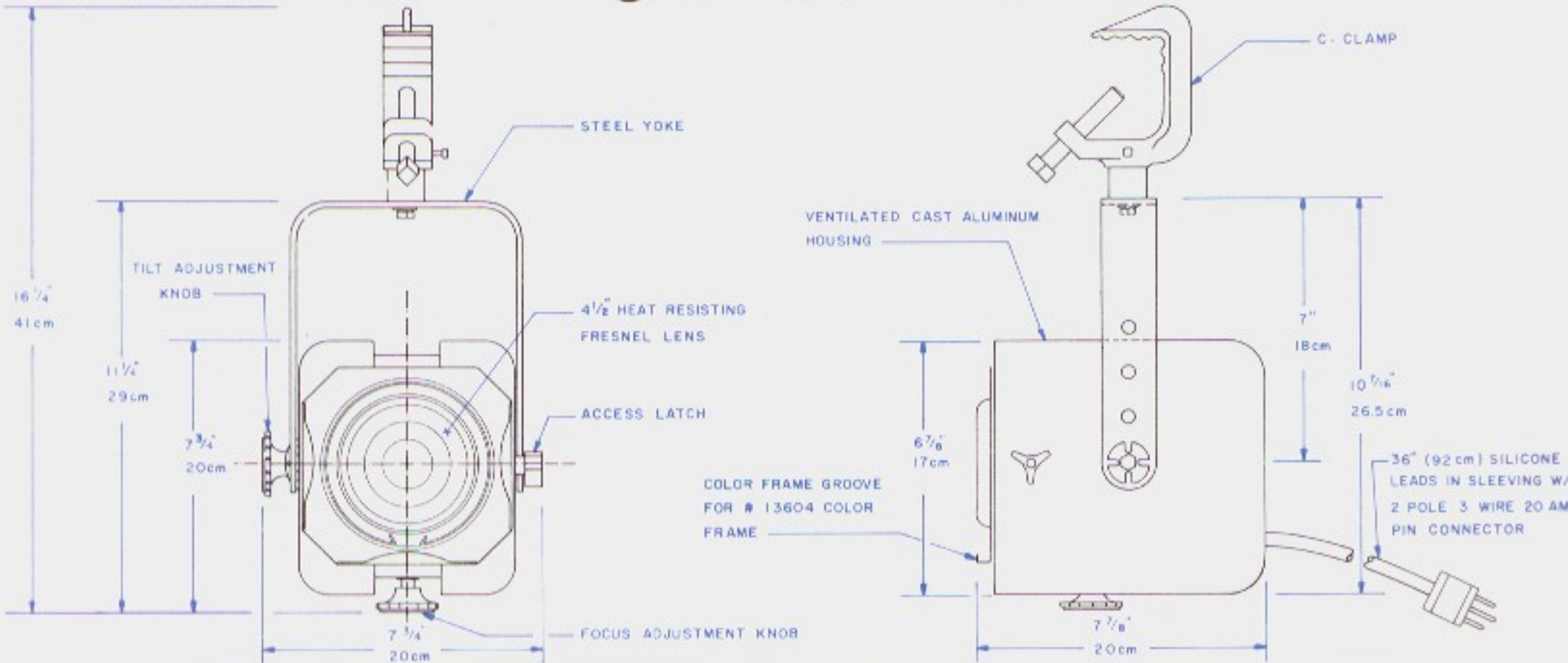

THROW DISTANCE (SPOT)

(SPOT)

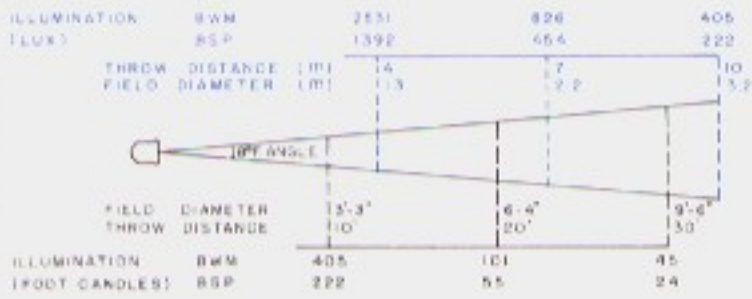

CANDLEPOWER DISTRIBUTION CURVES (SPOT)

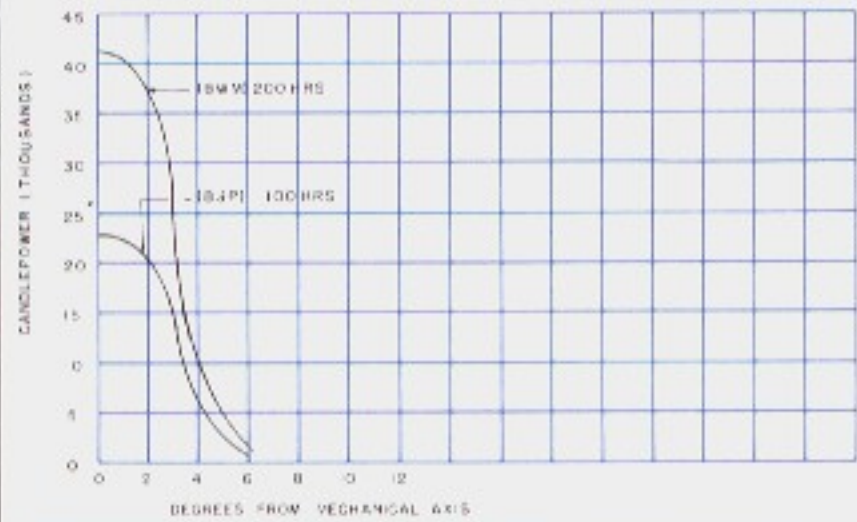

THROW DISTANCE (FLOOD)

(FLOOD)

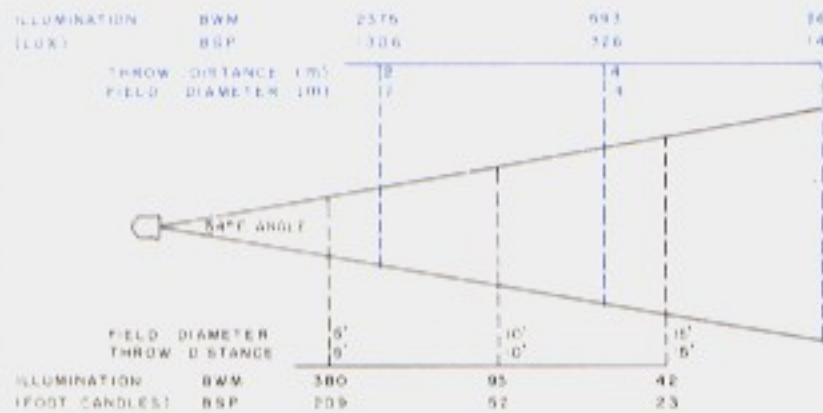

CANDLEPOWER DISTRIBUTION CURVES (FLOOD)

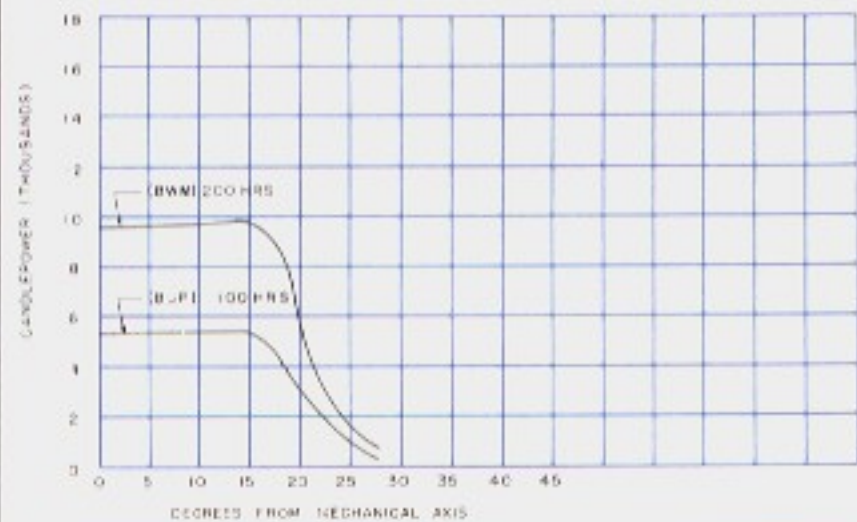

LAMP INFORMATION

LAMP ANSI CODE	WATTS	VOLTS	BULB	LIFE (HOURS)	*K	LUMENS
BSP	500	120	T-6	100	3200	11500
BWM	750*	120	T-8	200	3200	21000

\*Not U.L. Listed

Kliegl

32-32 48th AVENUE, LONG ISLAND CITY, NEW YORK 11101  
TEL: (212) 786-7474  
TLX: 960156