

Kliegl 400 Watt 3 1/2" Klieglight

Kliegl Model 1343

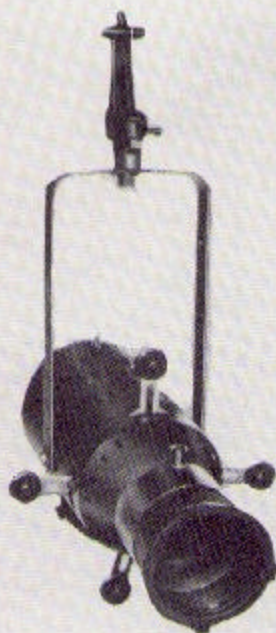

QUICK SELECTOR GUIDE

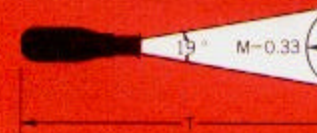

TYPICAL THROW DISTANCE
3-9 meters; 10-30 feet
Field Dia. (F) = Throw Distance (T)

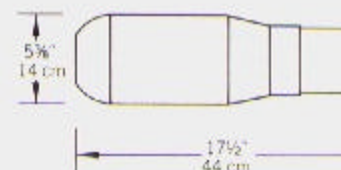

Weight: 9 Lbs. 3.8 Kgs.

SPECIFICATIONS

Ellipsoidal reflector spotlights to consist of an aluminum and sheet steel housing, ventilated so that the ambient temperature of the sockets shall not exceed 350°C. Access for relamping and maintenance is by means of hinged rear body with quick acting latch. Fixture support shall be a rigid iron yoke with "C" clamp for up to 2" pipe. Total fixture weight shall not exceed 9 pounds. Optical train shall contain a specular Alzak® aluminum, ellipsoidal reflector; pattern slot; four framing shutters of titanium alloy stainless steel with insulated adjustment handles; dual 3 1/2" diameter heat resisting piano-convex lenses and an adjustable lens tube for focusing. Electrical system to be grounded and consist of 2 single pole, recessed contact sockets (for a 400 watt, T3 tungsten halogen lamp) attached to 36" silicone rubber leads (UL type SF2, 200°C. rated) in high temperature sleeving and terminating in a 2 pole, 3 wire 20A pin connector. With a 400 watt, 250 hour lamp the unit shall produce a field angle of 19° which equals or exceeds 21,000 candlepower and shall meet all performance standards listed in the manufacturer's current catalog for this item. Unit to be KLIEGL #1343.

Provide _____ KLIEGL #1343 fixtures, each furnished with _____ color frame(s) and _____ lamp(s) with ANSI code # _____.

Standard equipment includes "C" clamp and 2 pole, 3 wire 20A pin connector. Lamps, color frames or other required accessories must be listed in the specification and will be furnished at additional cost.

Fill in Project
Information Here

ACCESSORIES

11340	Standard Color Frame
31340	Pattern Holder
41340	Set of 16 Patterns
1850B	"C" Clamp (furnished as standard equipment)
1860C	18" "C" Clamp Side Arm
1415	18" Spoke Base Floor Stand
1420	19" Roller Caster Floor Stand
51340	Top Hat

For color changers, color wheels and special fasteners refer to Kliegl Accessories Catalog.

CONNECTORS

955G	2 Pole 3 Wire 20A Pin Connector (furnished as standard equipment)
------	---

Kliegl Model 1343

400 Watt
3 1/2" Klieglight

Data from ETL Report #414031



U.L. Listed and Labeled

Union Made in the U.S.A.

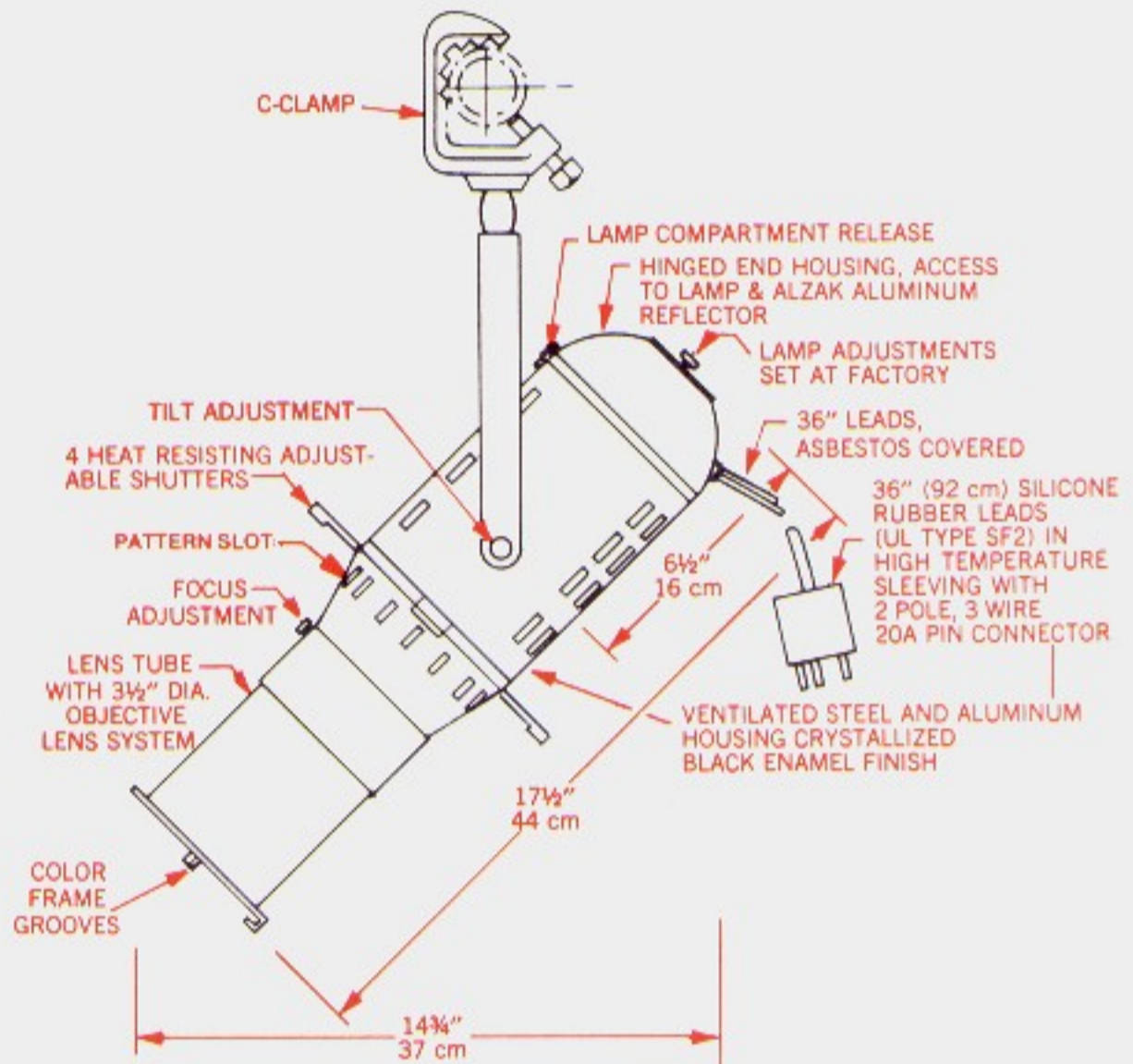
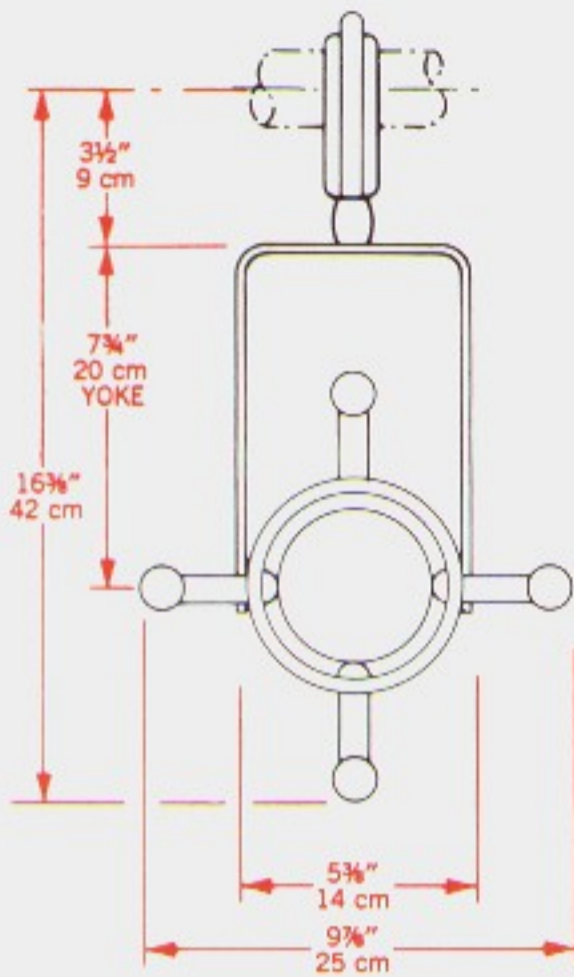

THROW DISTANCE

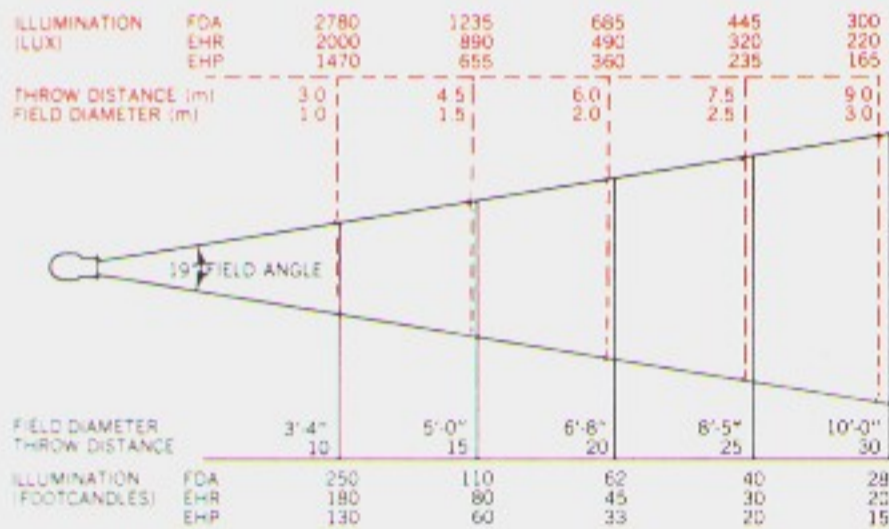

CANDLEPOWER DISTRIBUTION CURVES

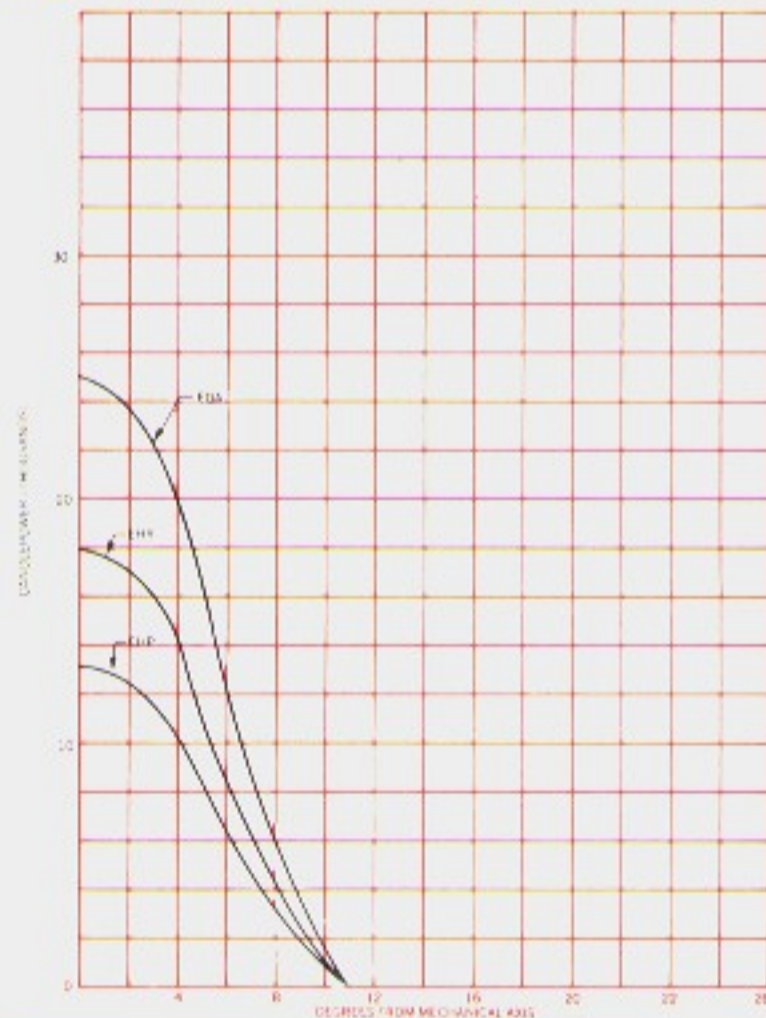

LAMP INFORMATION

LAMP ANSI CODE	WATTS	VOLTS	BULB	LIFE (HOURS)	°K	LUMENS
EHP	300	120	T-4	2000	3000	5,500
FDA	400	120	T-4	250	3200	10,400
EHR	400	120	T-4	2000	3000	7,500